

yy y 0go r q/hqco 0eqo

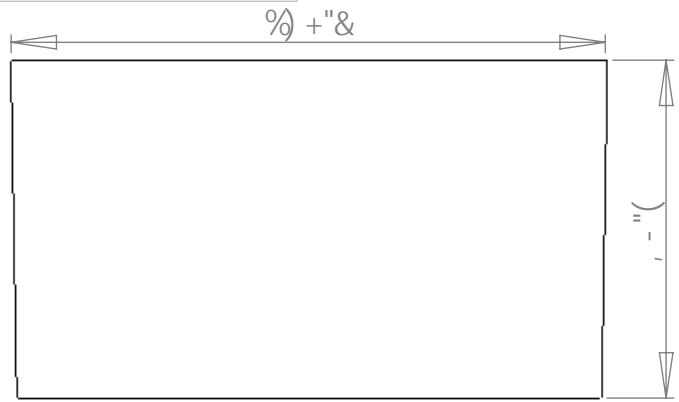

65 G9 G8 9' J 9K

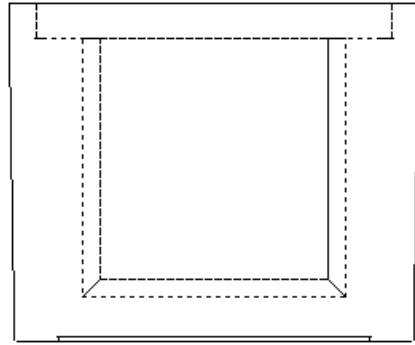

: FC BHJ 9K 'C : '65 G9

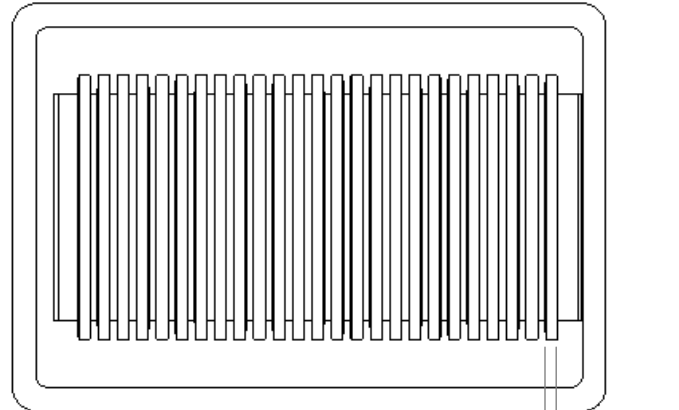

65 G9 HC D'J 9K

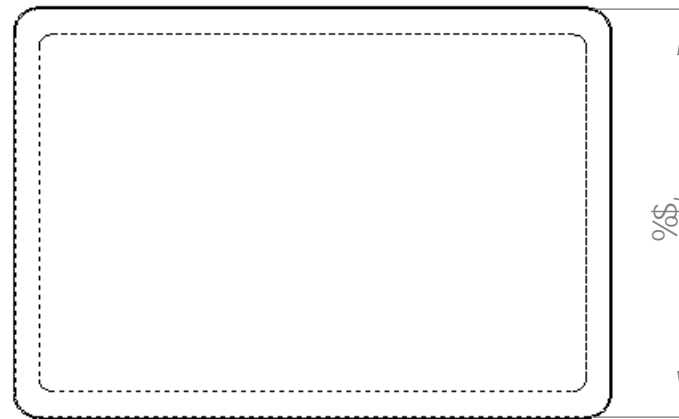

@8 HC D'J 9K

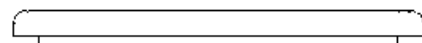

G8 9' J 9K 'C : '@8

HF5BGD5F9BH@8 G<C K G  
G@C HG: C F '&' D7 G'C : ; @5 GG

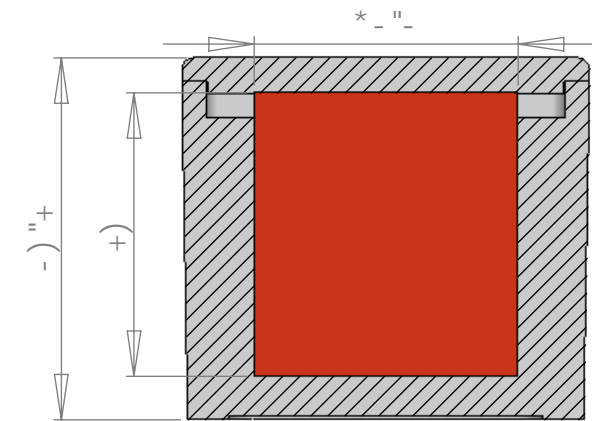
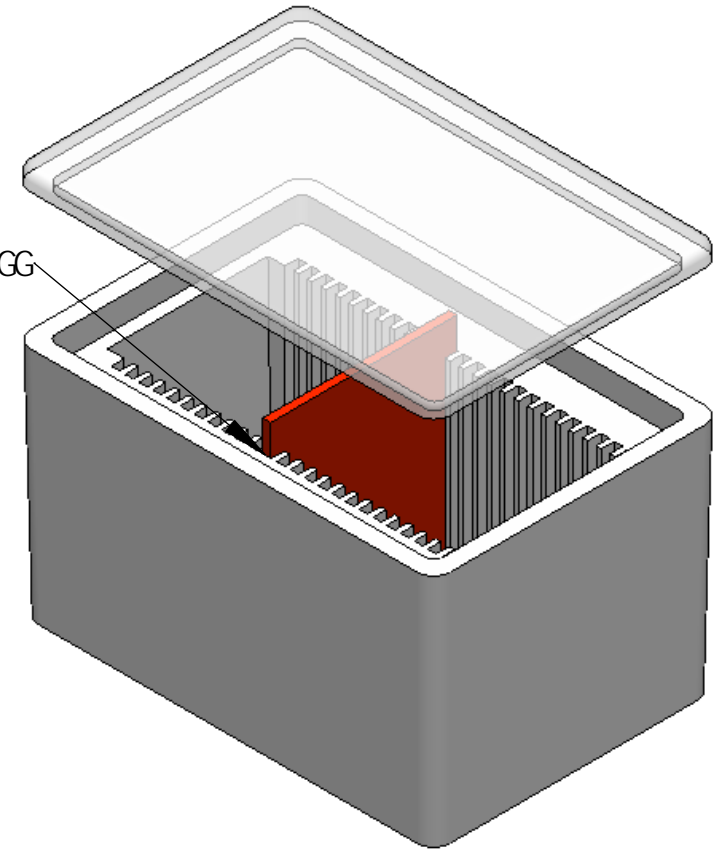

7 I HG97 HC B 'K #k 'D5 FH-B 'D@5 7 9

BchY.

%&'A UHf]U 'Hc 'VY '\* ( [ # 'XYbg]hmf( "\$ `V#h L'9DGž

GhUjW8 ]gg]dUhj Y

&L'%8 Y[ fYY '8 fUZiHMD

' L'8 ]a Ybg]cbg'g\ck b 'UfY ]'b'a ]`]a YHfYfg

DFCDF-94FM5B87CB:-89BH5@  
H:9 B: C FA 5HC B 7 CBH5 B98 -B H-G  
8F5K B: -GH:9GC @DFC.D9F HMC:  
Vgo r q'Rrcule'E q0'Kpe0 5BM  
F9DFC 8I 7 HC B -B D5FHCF 5G5 K <C @  
K #k:C I HH:9K F-H9B D9FA -GGC B C:  
Vgo r q'Rrcule'E q0'Kpe0 G  
DFC <-6+98"

		I B @GGC H:9FK @9 QD97 -98.	B5A 9	85H9	<b>Vgo r q'Rrcule'E q0'Kpe0</b>
		8 A 9BGC BG5F9 B 'B7 <9G HC @F5B7 9G : F57 HC B5 @± 5B: I @5F: A 57 <± 69B8 ± K C D@5 7 9897 -A 5@± H:F99D@5 7 9897 -A 5@±	8F5K B	GYj Yb: 5'Urc ffY	
		#HFD9H: 9C A 9F-7 HC @F5B7 B: D9F.	7 <97 ?98		&\$G&, \$\$
		A 5HFF-5@	9B: '5DDF"		
B9LH5GGM	I G98 C B	: B G<	A: ; '5DDF"	E "5"	GAP 8K ; "'BC "
		5DD@7 5HC B	7 C A A 9BHG		F9J
		8C BC HG7 5 @8F5K B:			G7 5 @9. %&
					G<99H% C : %