

TOP VIEW OF BASE

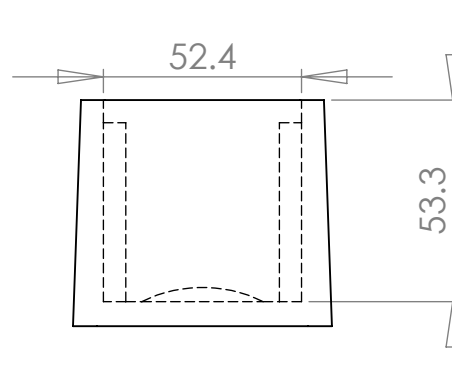

FRONT VIEW OF BASE

TRANSPARENT LID SHOWS SLOTS FOR 10 PCS.

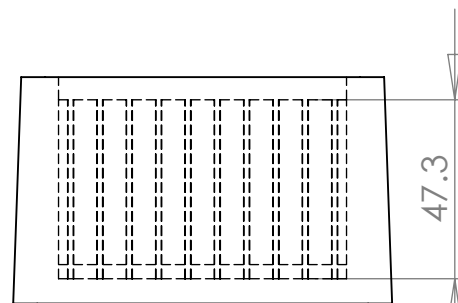
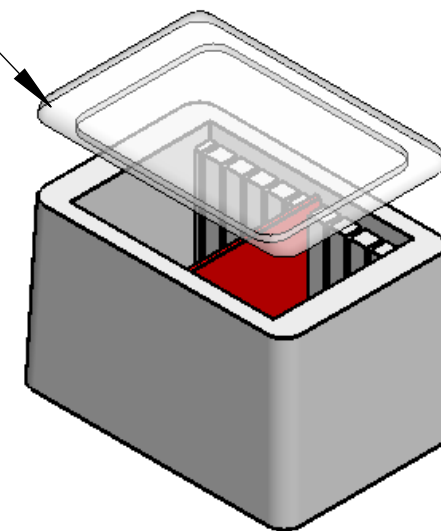

SIDE VIEW OF BASE

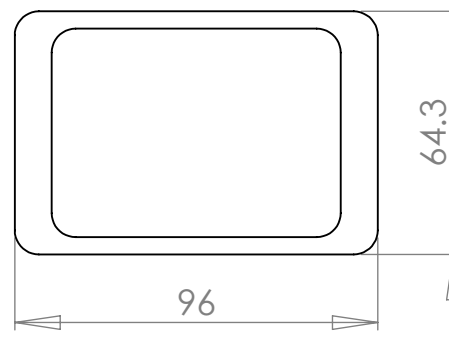

TOP VIEW OF LID



FRONT VIEW OF LID

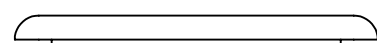
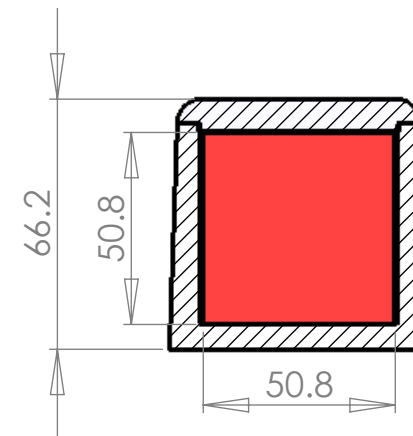

SIDE VIEW OF LID

- Note:**
- 1) Material To be 64g/l density (4.0 lb/ft³) EPS, Static Dissipative
 - 2) 1 Degree Draft TYP
 - 3) Dimensions shown are in millimeters

PROPRIETARY AND CONFIDENTIAL
 THE INFORMATION CONTAINED IN THIS DRAWING IS THE SOLE PROPERTY OF Tempo Plastic Co., Inc. ANY REPRODUCTION IN PART OR AS A WHOLE WITHOUT THE WRITTEN PERMISSION OF Tempo Plastic Co., Inc. IS PROHIBITED.

		UNLESS OTHERWISE SPECIFIED:		NAME	DATE	Tempo Plastic Co., Inc.	
		DIMENSIONS ARE IN INCHES		DRAWN	Steven Alatorre	July 1, 2009	TITLE: 10S-2062
		TOLERANCES:		CHECKED			
		FRACTIONAL ±		ENG APPR.			
		ANGULAR: MACH ± BEND ±		MFG APPR.			
		TWO PLACE DECIMAL ±		Q.A.			SIZE DWG. NO. REV
		THREE PLACE DECIMAL ±		COMMENTS:			
		INTERPRET GEOMETRIC TOLERANCING PER:					SCALE: 1:2 SHEET 1 OF 1
		MATERIAL					
NEXT ASSY	USED ON	FINISH					
APPLICATION		DO NOT SCALE DRAWING					