

yy y 0go r q/hqco 0eqo

8

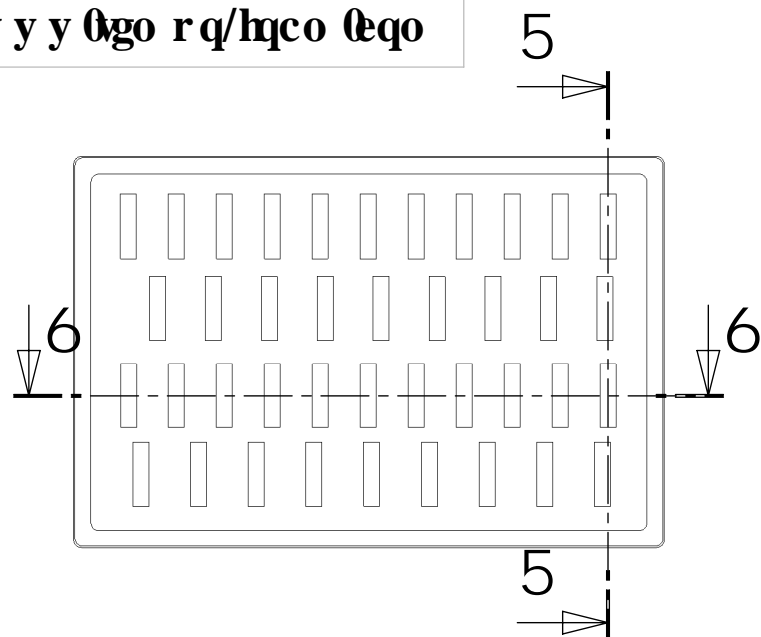

G97 H€ B '5!5'
G7 5 @9'%'."

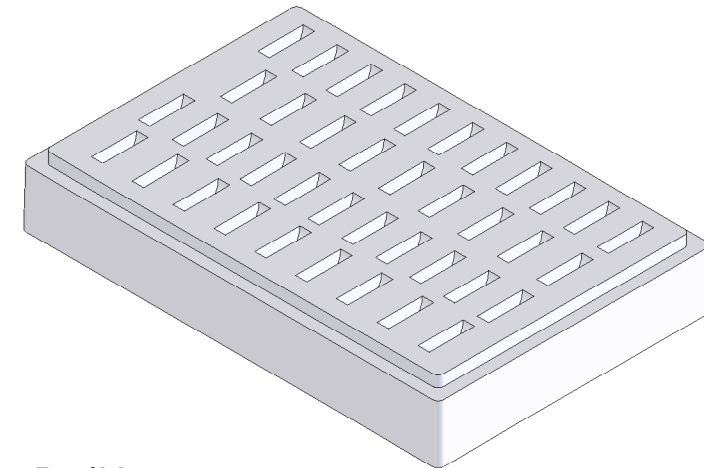
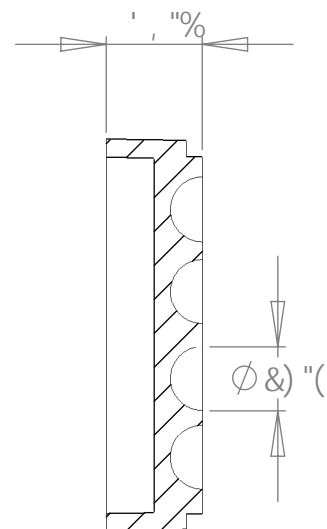

BchY.
%&'A UYf]U' Hc 'VY' * ([# 'XYbg] m f ("\$ `V#h £'9DG
&£'8Y[fYY '8 fUZhHMD
' £

7

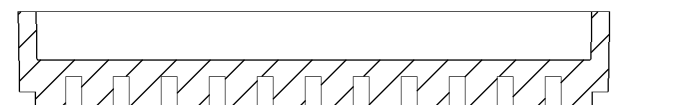

G97 H€ B '6!6'
G7 5 @9'%'."

6

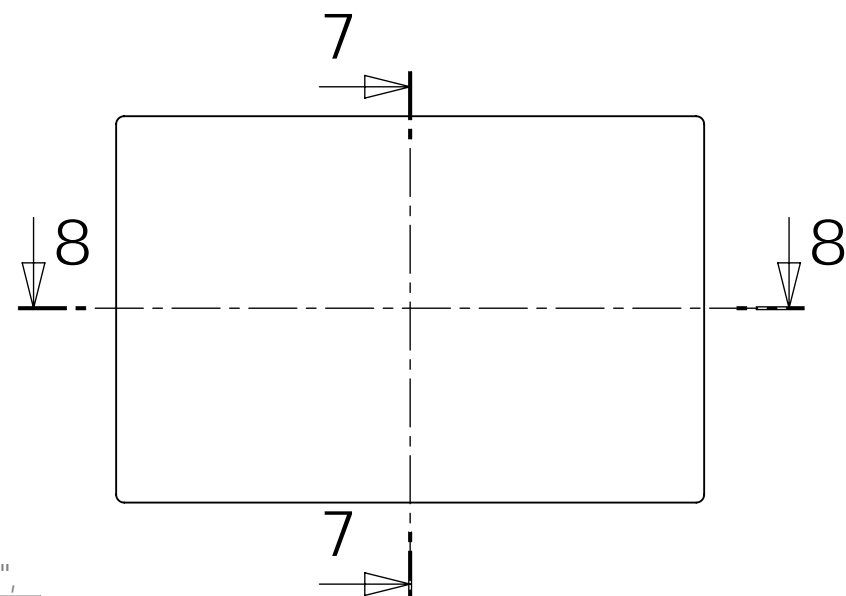

G97 H€ B '7!7'
G7 5 @9'%'."

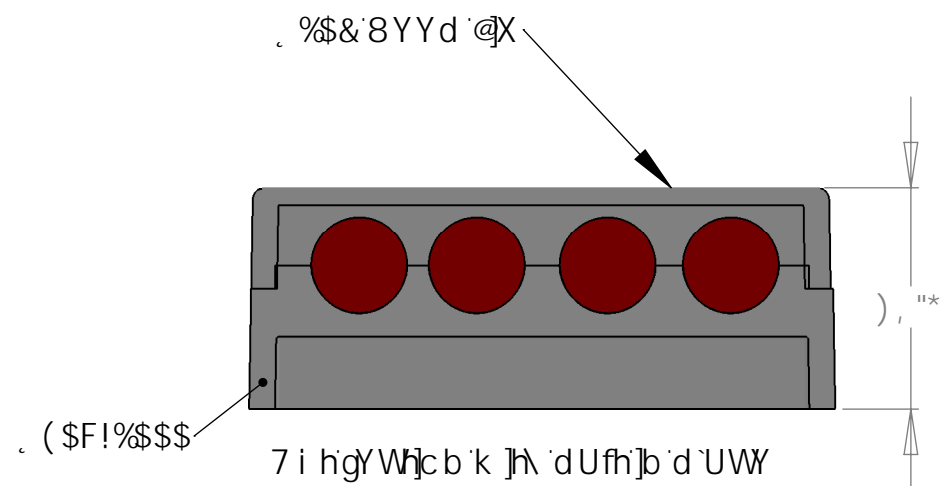
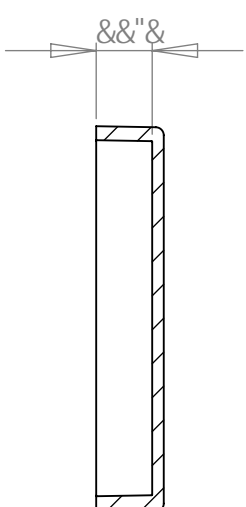

5

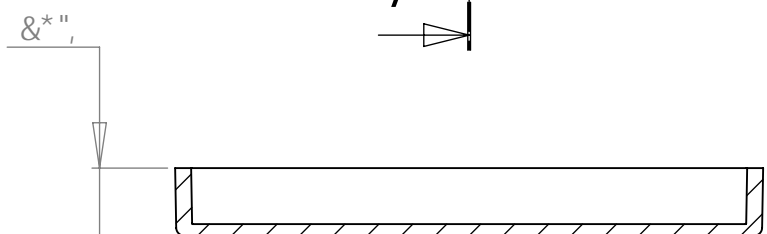

G97 H€ B '8!8'
G7 5 @9'%'."

DFCDf-545FM5B87CB: 89BH5@
H:9 B: CFA 5HC B 7 CBH5 B98 B H-6
8F5K B: -GH:9GC @DFC.D9F HMC:
Vgo r q'Rrcule'E q0'Kpe0 5BM
F9DFC8I 7HC B -B D5FHC F 5G5 K <C @
K H:C I HH:9K F-H9B D9FA -GGC B C:
Vgo r q'Rrcule'E q0'Kpe0 5
DFC <6498"

I B @9GC H:9FK @9GD97 ±98.	B5A 9	85H9	Vgo r q'Rrcule'E q0'Kpe0
8 A 9B GC BG5F9 B A A HC @F5B7 9G : F57 HC B5 @± 5B: I @5F: A 57 <± 698 8 ± HK C D @57 9897 A 5 @± H: F99D @57 9897 A 5 @±	8F5K B	>i b]cf	
8HFDF9H: 9CA 9H-7 HC @F5B7 B: D9F.	7 <97 ?98	9B: '5DDF"	(\$F!%\$\$\$
A 5HF-5 @	A: ; '5DDF"	E "5"	
B9LH5GGM	I 98 C B	7 CA A 9BHG	GA9 8K ; "'BC "
5DD@7 5HC B	8C BC HG7 5 @98F5K B:		F9J
			G7 5 @9: %&
			G<99H% C : %